

MO-150 Series Halogen Light Source
For
Fiber Optic Light Guides

















Features, Specifications, and Operation Instructions

Table of Contents

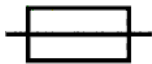
Table of Symbols	3
General Information and Warnings.....	4
Product Description.....	5
Product Specifications.....	5
Light Output Port.....	7
Input Power.....	7
Counterweight.....	7
Installation Guidelines	7
Indications for Use	8
Use With Other Equipment.....	8
Cleaning.....	11
Troubleshooting	11
Options	13
-B Unit is supplied without two front panel Brand Name labels (rear label remains)	13
-F Unit is supplied with filter carrier	13
Filter Installation Into Filter Carrier	13
-E External control option	13
Figure OPT-1	14
Figure OPT- 2	15
Figure OPT- 3	15
-P Micro Processor Option (Set for RS-232).....	16
-P4 Micro Processor Option (Set for RS-485).....	16
Figure OPT-4	17
Figure OPT- 5	18
Programming the Microprocessor Option	18
-PE Ethernet Option	20
-CE Option	20
Accessories.....	20
Customer Support.....	21
Service/RMA Policy.....	21
Warranty	22
Liability.....	23

Table of Symbols

	CE Mark		Electrical Hazard Refer to user manual
	WARNING! Refer to user manual		Alternating Current
	Off		Intensity
	ON		Refer to user documentation
	ETL Mark		Catalog Number
	Fuse		Serial Number
	WEEE mark		Manufactured by

NOTE:

Light source images in this manual are included to aid in the user's understanding and operation of the device. While they are an accurate representation of the actual product, some of the cautionary labelling required for compliance is not shown.

The wording and positioning of cautionary labels will change from time to time. Therefore, they have been intentionally left out of the images.

General Information and Warnings

**FTI Customer Service Department North America
1 Quasset Road
Pomfret, CT 06258 USA
800.433.5248 toll-free within US and Canada
+001 860.928.0443 International
Monday - Friday 8AM - 5PM EST USA
+001 860.928.7665 Facsimile
E-mail: info@fiberoptix.com**

The FTI light source has been engineered with safety as a priority. To reduce the risk of **FIRE, ELECTRICAL SHOCK, EXPOSURE TO EXCESSIVE UV RADIATION OR INJURY TO PERSONS**, the user is cautioned to observe the following:

1. Read and follow all instructions in this manual.
2. Turn off / unplug power to the unit and **allow to cool before replacing bulb (lamp)**.
3. Use only **150-Watt, 21 Volt, Halogen** or lower wattage rated bulb (lamp).
4. **Do not touch the bulb (lamp) at any time.** Use a soft cloth. Oil from skin may damage bulb (lamp).
5. **The bulb (lamp) gets hot quickly!** Only contact the switch or plug when turning on.
6. **Never look directly at the light port** when the unit is on; your eyesight may be compromised.
7. **Do not remain in light** if skin begins to feel warm.
8. Take care removing fiber optic components or handling the light source; **some surfaces will be hot after use.**
9. **Do not operate the portable luminaire** with a missing fiberoptic light guide.
10. **Do not use or place flammable materials near the unit.**
11. **Do not use this unit near water** or in an area with excessive moisture.
12. **Do not defeat the safety purpose of the 3-prong ground plug.** Use only the approved power cord supplied with the unit. Route cord so it will not be pinched, severed, or stepped on.
13. **Do not defeat the purpose of the fuse.** Replace only with the fuse type described in the manual and as marked on the unit.
14. Do not remove the cover. **High voltage is present internally.** Removing the cover exposes the person to the possibility of electrical shock. Tampering with the electronics will void the warranty.
15. **Do not block ventilation openings** and do not impede airflow; Either condition will cause the unit to malfunction.
16. If you wish to clean the unit, allow it to cool, **disconnect the power and use only standard detergent type cleaners**; do not use solvents or petroleum distillates. Never "spill" liquid on the unit. Allow the unit to cool before cleaning.
17. **Keep all safety and operating instructions** for future reference.

18. **Do not service the unit beyond what is described in this manual.** Attempting repair of electronic or logic circuits without prior written approval of FTI will void the warranty. Should the light source fail at any time, return it to an authorized FTI service center.
19. For a Return Material Authorization, contact the FTI Customer Service department @ 800.433.5248

Product Description

The FTI MO-150 light source was designed to be backward compatible with previous FTI fiber optic accessories. Furthermore, with the proper adapter, the light sources can accept all major brands of fiber optic components from Techniquip, IT, Schott, Dolan Jenner and others.

Please note: The MO-150 uses a unique adapter configuration. Use only FTI supplied adapters

The light source is based on FTI PN FTIII25664 (MO-150) having a 150 watt maximum drive level supporting a number of options. This light source provides consistent intense white light output to all types of fiber optic illumination components. An optional IR absorption filter can remove all IR above 700nm... making the output “cold”.

The light source can be adapted to most environments and specifications. This manual will cover all available options. Switch mode operation is employed throughout the design for improved stability, high efficiency, lower temperature operation.

Product Specifications

Improvements may result in specification or feature changes without notice.

General Specifications

Physical Dimensions

Overall Height:	5.0” (121 mm)
Overall Width:	7.625” (205 mm)
Overall Depth:	7.75” (219 mm)
Unit Weight:	5lbs. (2.3 Kg) including cord

Adapter Receptacle: 1” (25.4mm) OD.

Adapters: FTI, Storz, ACMI, Wolf, Olympus, Pilling, Chiu, Schott, Fostec, Dolan Jenner, Volpi, Others

Output 150 Watts of Radiometric Power from a 21 Volt Tungsten Halogen Lamp.

Power Requirements: 100-240 VAC, 50/60Hz
Power Consumption: 170 watts Max.
Fuse: 2A Type F Quick Blow
Regulatory Approvals UL, CSA, CE
Lead Free Status / RoHS:
Status: Lead Free, RoHS Compliant

Controls and indicators:

Power Switch, Rocker Type (Front Panel)
Over Temperature Indicator LED (Front Panel)
Intensity Control, 0%, (0V Lamp V) Full CCW, 100%, (21V Lamp V) Full CW

The base model (**FTIII25664**) is configured as follows:

EKE 150-Watt Halogen Lamp
Single Fixed Output Port, with 0.625" adaptor (as accessory; installed by user)
North American Power Cord

Available Option Configurations:

FTIII25664

- B** No brand labelling, no adaptor
- F** Optical filter carrier
- E** External Connector port (for use with wired remote sold separately)
- P** RS232 Communications (includes appropriate port)
- P4** RS485 Communications (includes appropriate port)
- PE** Ethernet Communications (includes appropriate port)
- CE** International Power Cord

Light Output Port

The light output port accepts a large selection of light guide adaptors, for virtually any light guide being produced in the current marketplace. See appendix A for a current offering of adaptors.



Light Output Port, centered over the Lamp, accepts adaptors for all makes of fiber optic cable. FTI's standard .625" Diameter adaptor is supplied as the default.

Figure 1 (Light Output Port)

Input Power

"Default" Unit Shipped with North American Power Cord

"CE" Unit Shipped with International Power Cord

Counterweight

This consists of a rectangular steel bar that has been powder coated with the same finish as the light source chassis. It is permanently fastened to the bottom rear of the unit to provide additional stability in applications requiring "Goose Neck" light guides. The weight of this bar is 1.3 pounds (0.6Kg).

Recommended Conditions

- Operating
 - Temperature 5°C to 40°C
 - Humidity 10% to 85% Relative Humidity, Non-Condensing
- Storage
 - Temperature 5°C to 50°C
 - Humidity 10% to 85% Relative Humidity, Non-Condensing

Installation Guidelines

To ensure proper operation of the light source, the following conditions must be met:

Minimum Clearance

Rear	Sides and Top
1.5" (37 mm)	.5" (12.5 mm)

1. Do not block any air vents.
2. Proper ventilation must be provided at all times. Failure to do so may cause intermittent operation and/or failure of the electronics.
3. Avoid areas of excessive vibration.
4. **CAUTION:** Dust accumulation will restrict air flow which can damage the unit.
(See Cleaning Section for recommendations)

Indications for Use

The MO-150 light source is intended to provide white light to an accessory fiber optic light guide for illumination.

Use With Other Equipment

Any equipment connected to the light source must be certified to IEC/ISO standards appropriate to the equipment and application.

The user must not compromise the performance and safety requirements of the light source when used with, or near other equipment. The light source shall not be immediately adjacent to, beneath, or above other electrical equipment. Follow the minimum clearance guide lines given in the Installation Section.

All electrical equipment generates and receives electromagnetic and radio frequency interference (RFI) from other equipment. Use of the light source near other equipment may adversely affect the function of the light source or other equipment. It is the user's responsibility to verify using the light source with or near other equipment will not adversely affect the performance of either unit.

Use of portable or other Radio Frequency (RF) telecommunications equipment may affect the performance of the light source.

Use of components other than those supplied by FTI may adversely affect electrical emissions or immunity.

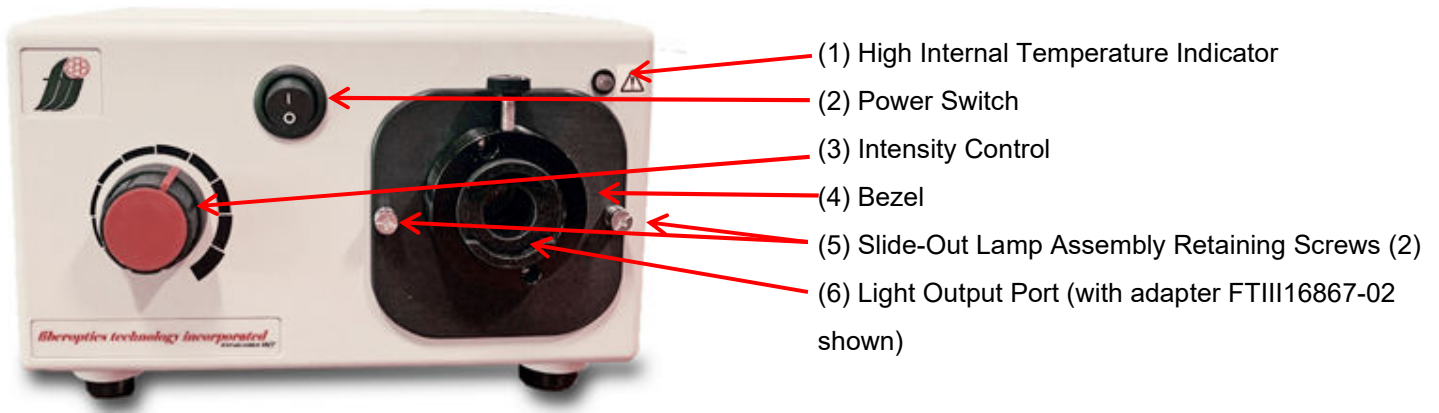

Figure 2 (Front Panel)

Operation

The light source unit can be used around the world, operating with line voltages in the range 100 to 240 VAC and 50 or 60 cycle operation.

1. Make sure the power switch (*Figure 2 - Front Panel, item 3*) is in the “**OFF**” position.
2. Plug the power cord into the power connector (*Figure 3 - Rear Panel, item B*).
3. Plug the other end into an AC power source.
4. If using a color or heat filter, see Filter Option (-F) Section.
5. Insert the appropriate adapter into the bezel, aligning the through-hole in the adapter with the thumbscrew in the top of the bezel. Tighten the screw to capture the adapter, but not too far as to obstruct the opening for the fiber optic component.
6. Insert the selected fiber optic component.
7. Make sure the captive thumbscrew on the bezel goes through the adapter and locks the input of the fiber optic component in place.
8. Toggle the power switch *Figure 2 - Front Panel, item 2* to the “**ON**” position.
9. Adjust the light intensity with the intensity control knob (3) *Figure 2 (Front Panel)* to desired setting.
10. To turn the unit off, toggle the power switch to the “**OFF**” position.
 - Note: After turning unit off, wait 5 seconds before turning it back on.
11. Always have a light guide inserted into the output port when in use.

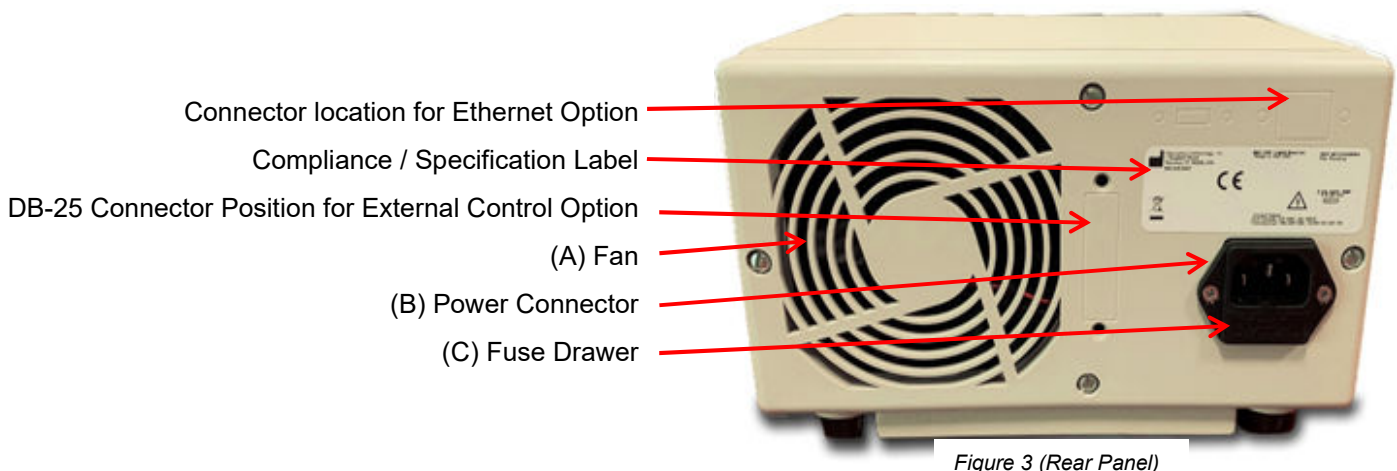

Figure 3 (Rear Panel)

Lamp Intensity

In the world of filament lamps, halogen lamps are by far the most consistent, but even halogen lamps degrade over their lifetime, most by an average of 15%. Furthermore, all lamps are not created equal. As proven by independent research, new lamps, of the same brand and model number, may vary +/- 20% in maximum intensity, depending on the batch.

Special Note:

Under normal conditions, lamp manufacturers recommend halogen lamps be operated above 80% of their rated intensity for optimum and stable lamp performance.

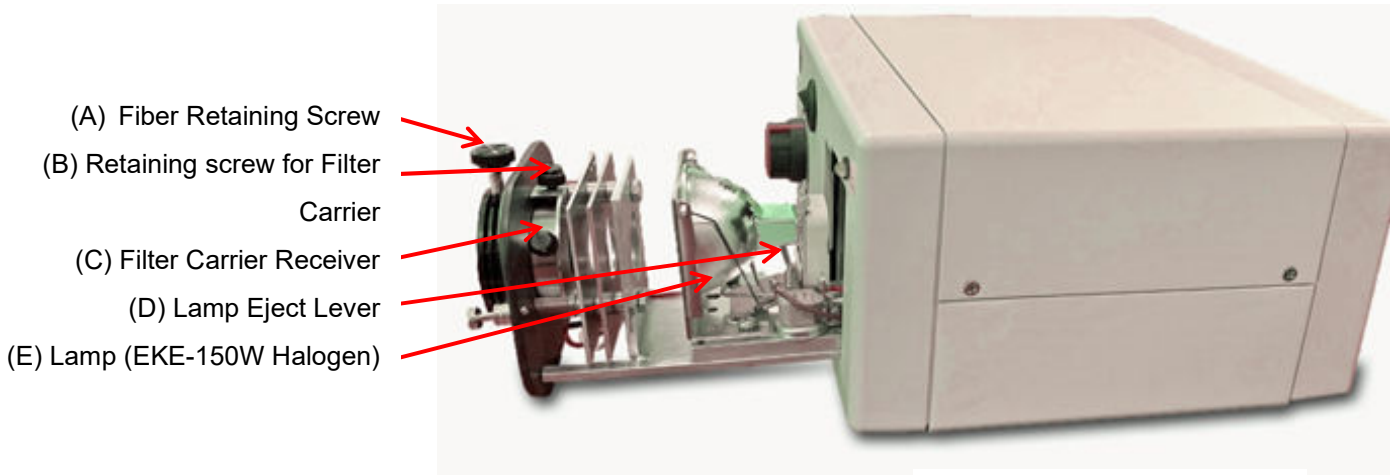

Figure 4 (Slide Out Lamp Assembly)

Maintenance

Lamp Replacement

CAUTION

To reduce the risk of fire – Use 150 Watt or smaller, 21 Volt type Halogen lamp or equivalent. See *Figure 4 - Slide Out Lamp Assembly, item E* for lamp type.

1. Depress the power Switch (*Figure 2 - Front Panel, Item 2*) to the "OFF" position.
2. Allow the lamp to cool. CAUTION: Lamp, lamp socket, and surrounding surfaces may be hot!
3. Turn the slide-out lamp assembly retaining screws (6) *Figure 4 (Slide Out Lamp Assembly)* CCW until they disengage from the front panel. Gently pull the slide-out lamp assembly forward to gain access to the lamp and lamp holder.
4. Push the lamp release lever (D) *Figure 4 (Slide Out Lamp Assembly)* toward the lamp socket to raise the lamp and remove it from the ceramic lamp socket, pulling the lamp from the socket.
5. Insert a new lamp into the socket. Making sure lamp release lever has been returned to its original forward position, push the lamp all the way down into its holder.

Be careful not to touch the bulb or the inside of the reflector. Fingerprints will affect the light output.

Under normal use, the fuse should not require replacement. The purpose of the fuse is to protect the electronics from failure due to inrush. Should it become necessary to change the fuse, replace the same type (2 Amp/Fast Blow) to insure long life and best performance.

Cleaning

The housing has a durable finish that should retain its original luster for many years. Cleaning the exposed areas with a commercial glass cleaner or common household detergent will help maintain the finish.

Unplug and remove the power cord from the IEC connector on the back of the unit. Wipe the exposed areas of the housing with a soft cloth or paper towel moistened with general purpose cleaner.

CAUTION: Do not use excess water, treated cloth, harsh cleaning agents or sprays. Use cleaning fluid sparingly. If fluid spills into the interior, let the unit dry thoroughly before using.

Periodically, dust should be removed from the unit using a vacuum or commercially available cans of compressed air. Pay special attention to the fan blades at the rear of the unit, the air vents in the front (around the bezel), and on the bottom of the main housing.

Troubleshooting

If you are unsuccessful at resolving the following conditions, contact FTI for a Return Material Authorization (RMA). Do not attempt to repair the light source. Tampering with the electronics will void the warranty.

- Fan operates, but unit has low light output.
Check the lamp to ensure that it is fully seated. See “Installing the lamp” section.
Check to make sure the fiber optic component is fully seated.
Check the lamp...a partial short in the lamp may cause low or intermittent output.
Check the intensity setting.
- Fan operates, but output is intermittent (every few minutes, lamp turns off and turns on).
The light source is running too hot. A thermal cutoff protects the circuitry from heat failure. Check air intakes and exhaust areas for dust or dirt accumulation.

Make sure minimum clearances are maintained. (See installation guidelines for

clearance information). Move the light source to another location. NEVER enclose the light source without adequate ventilation.

- Fan operates, but the light turns briefly on and then off.

The lamp may have a faulty filament. Turn the intensity control knob to maximum setting to test the lamp.

If the lamp fails, change the lamp following the instructions in this manual.

Examine the lamp socket assembly for damage and continuity.

- Fan operates, light is not on.

Replace the lamp.

- Fan does not operate, light is on.

Return to supplier or service provider.

- Fan and lamp are not working.

Make sure the power cord is inserted completely into the IEC connector and also into the correct power source. Check the power cord for damage. Check the fuse.

- Fiber input is burning.

Check the fiber type...it may be plastic and susceptible to burning, even with the use of a standard IR heat mirror.

Ask your supplier about the epoxy used to manufacture the fiber optic input...some epoxy types cannot withstand the high temperatures developed in the light source.

Check the lamp type. Only lamps with dichroic reflector coating should be used*.

Replace the lamp following the guidelines listed in a chart elsewhere in this manual.

Use an IR filter if possible. Fiberoptic inputs damaged by use of nonapproved lamp will void the fiber warranty.

****Some specially prepared fiber optic components are designed for use with IR type lamps. If you are using this type of fiber optic assembly, an IR lamp can be used with extreme caution, as the bezel temperature could exceed 130F.***

Options

-B Unit is supplied without two front panel Brand Name labels (rear label remains)

-F Unit is supplied with filter carrier

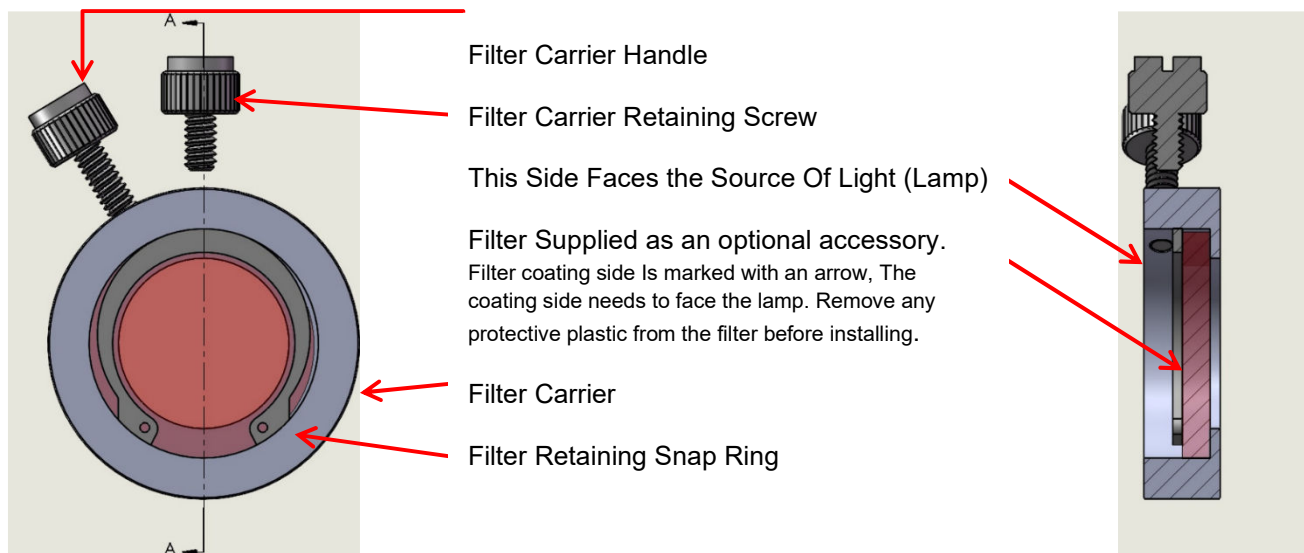

Figure 5 (Filter Holder option)

Filter Installation Into Filter Carrier

The filter (not supplied with the carrier) is installed in the carrier, coated side facing the lamp and carrier aperture. The carrier is then inserted into the filter receiver *See Figure 4 - Slide Out Lamp Assembly, item C*) in Maintenance Section.

-E External control option

This option is accessed through a DB-25 female connector mounted to the rear panel. This option is supplied for all microprocessor options described elsewhere in this manual. The following signals are provided by the -E option:

- Pin 11 External Intensity Ground: This is the ground pin for the external intensity signal.
- Pin 23 External Intensity Signal Input: This is the external intensity input signal 0-+5 VDC is the working range, producing 0-100% light output respectively.
- Pin 12 Internal Intensity Off Ground: This is the ground pin for the internal intensity off signal.

- Pin 24 Internal Intensity Off Input: This turns the internal intensity off when tied to Internal Intensity Off Ground, (disables front panel intensity control). This can be TTL, OC or Contact Switch.
- Pin 10 Light Off: This is the Ground pin for the Light Off Signal.
- Pin 22 Light Off: This shuts the light off when tied to the Light Off Ground pin. This can be TTL, OC or Contact Switch.
- Pin 13 Reference Voltage Ground: This is the reference voltage ground.
- Pin 25 + 5.1 VDC Reference Voltage: This reference voltage is available at up to 5ma max. This would normally be used to excite an external intensity pot or provide a reference for voltage for a customer D/A to produce an external intensity signal.

Some typical implementations and their function follow as shown in *Figures OPT-1,-2,-3* (These represent a small fraction of all possible implementations)

Note: To ensure that EMC compliance, the DB-25 male interface connector shell should be metal or metalized plastic, any wires leaving the shell must be shielded. The shield is tied to the shell and to earth ground at the signal end.

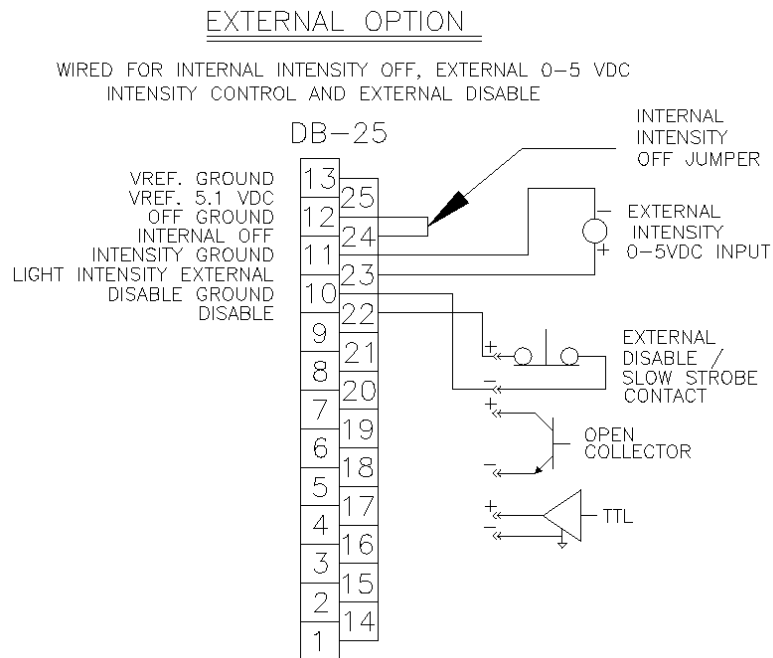

Figure OPT-1

WIRED FOR EXTERNAL DISABLE
USING INTERNAL INTENSITY CONTROL

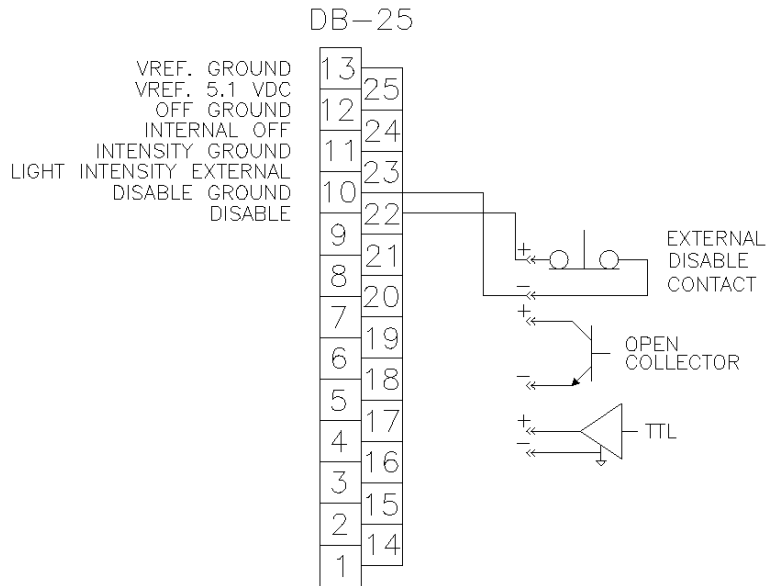

Figure OPT- 2

EXTERNAL OPTION

WIRED FOR INTERNAL INTENSITY OFF, EXTERNAL
INTENSITY CONTROL AND EXTERNAL DISABLE

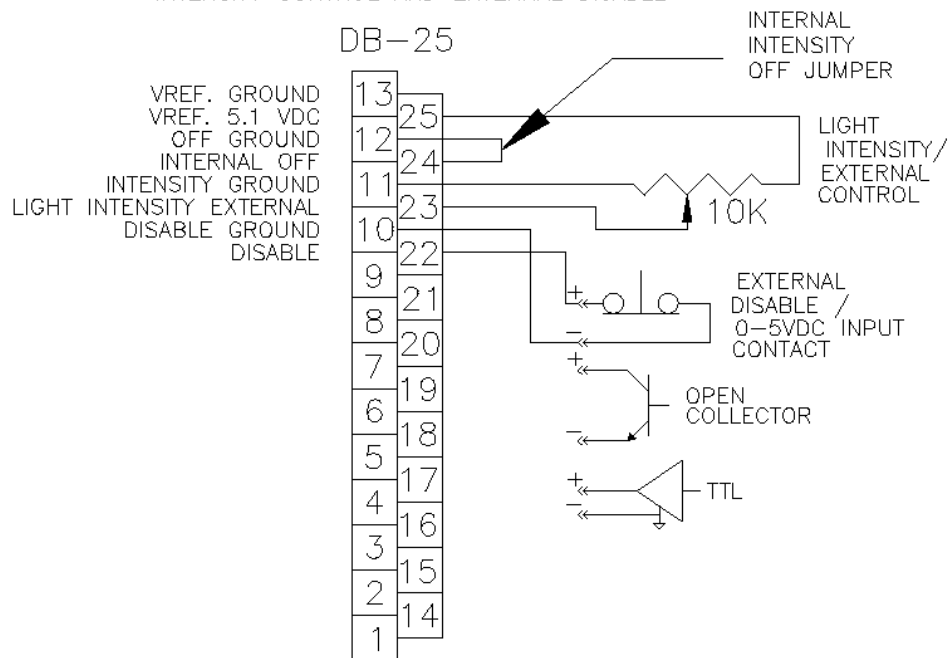

Figure OPT- 3

-P Micro Processor Option (Set for RS-232)

-P4 Micro Processor Option (Set for RS-485)

These options are microprocessor controlled and combined with the external control option. The capabilities of the module are as follows:

RS232 or RS485 communications are available (**9600 baud, 8 data bits, no parity, one stop bit**), jumper selectable. Ethernet communications can be provided as an additional option to the Microprocessor option.

Note: To operate with the above communications options, the users' equipment must have the appropriate communications port available (RS232, RS485 or Ethernet). Today many computers are provided only with USB ports and Ethernet ports. If RS232 or RS485 is desired but the users' equipment only has USB ports, there are a number of adaptors in the market to convert USB to RS232 or RS485. Contact FTI if additional help is required in selecting an appropriate adaptor.

- 0 - +5 VDC intensity output, intensity can be set to a voltage via the communications link. This will produce a 0% - 100% intensity output.
- Voltage reference input for providing a precise source for the intensity voltage output generator. +5.1 VDC typical as supplied by DB25 connector.

The above signals are provided on pins of the external control option DB-25 pin connector. The pinouts and signals are defined in the following:

- Pin 7 Not used
- Pin 19 Not used
- Pin 6 This is the Disable output ground.
- Pin 18 This is the Disable output signal.
- Pin 5 Not used
- Pin 17 Not used
- Pin 4 This is the intensity output ground pin.
- Pin 16 This is the intensity output pin used to provide a 0- 5 VDC output signal based a digital value transmitted over the communications link. (0%-100% intensity output range)
- Pin 3 This is the voltage reference input ground pin.
- Pin 15 This is the voltage reference input pin used by the intensity output voltage generator. Typical value is + 5.1VDC as supplied by the DB25 connector.
- Pin 2 This is the RS232 or RS485 ground pin

- Pin 14 This is the RS232 receive or RS485 Y/A pin.
- Pin 1 This is the RS232 Transmit or RS485 Z/B pin.
- Typical implementations and their function follow as Figure 4,5,6 on Page 18, 19.

(These represent a small fraction of all possible implementations)

An inter-module bus allows sensing presence of an over temperature condition, overcurrent condition and shutting down the PWM Driver. These conditions as well as other parameters and settings can be reported back via the communications link.

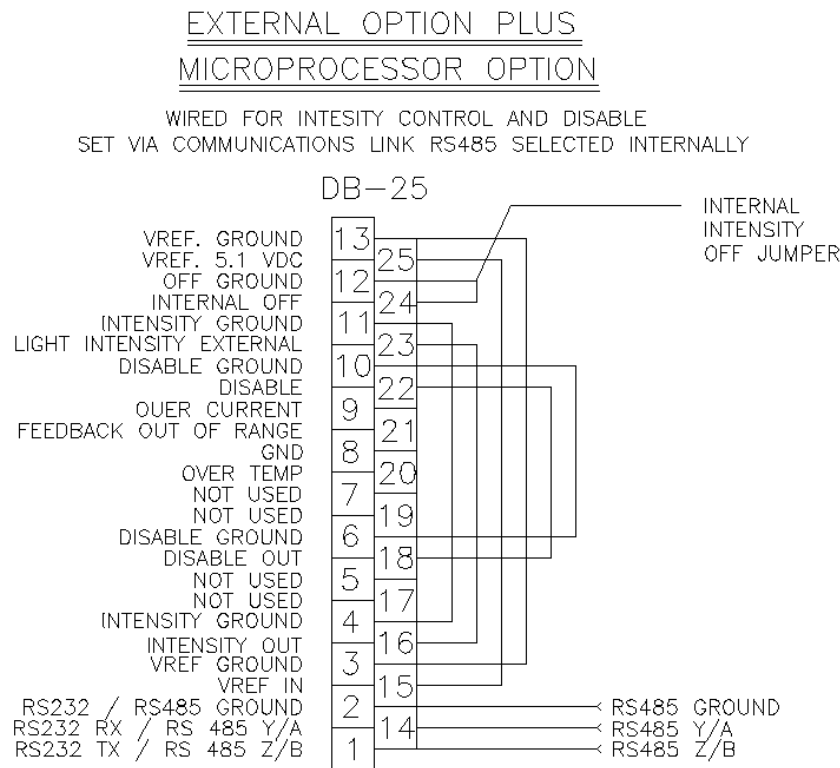

Figure OPT-4

Note: Some RS485 modules may require reversing the Y/A, Z/B connections for proper operation.

EXTERNAL OPTION PLUS
MICROPROCESSOR OPTION

WIRED FOR INTENSITY CONTROL SET VIA COMMUNICATIONS LINK
RS232 SELECTED INTERNALLY

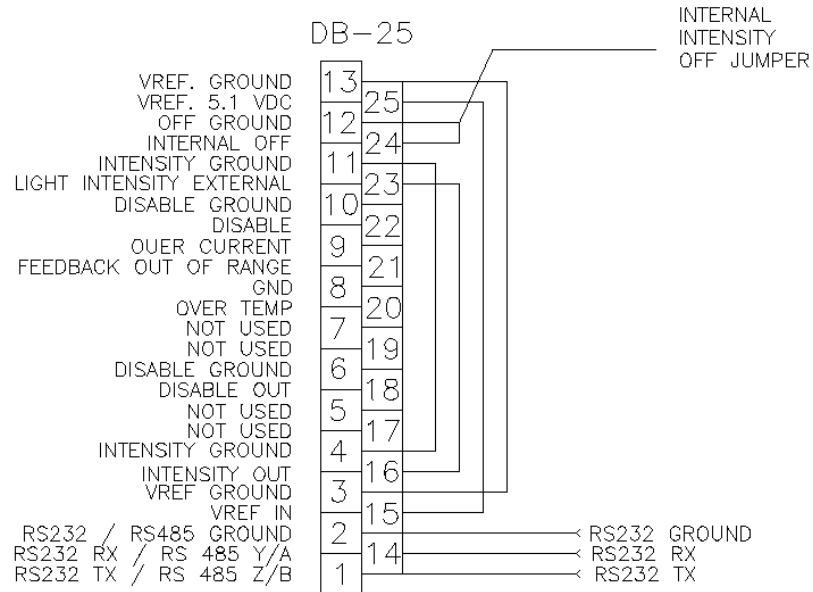

Figure OPT- 5

**Programming the Microprocessor Option
(9600 baud, 8 data bits, no parity, 1 stop bit)**

Message Structure

- \ Lead in character, start of message
- uuu Decimal unit ID Range = 0-255
- , End of decimal input marker
- y Lowercase single alpha command
- nnnn Decimal parameter Range = 0-255, 0-65536
- , End of decimal input marker
- <CR> Carriage return, end of message

Response Messages

- uuu Decimal unit ID Range = 0-255
- y Command received
- nnnn Parameter received

<CR><LF> Carriage return and line feed

Bad Parameter

uuu Decimal unit ID Range = 0-255

y Command received

? Parameter not valid

<CR><LF> Carriage return and line feed

Bad Command

uuu Decimal unit ID Range = 0-255

? Command not valid

<CR><LF> Carriage return and line feed

Global Commands

Unit ID 1-255 are unit specific commands, Unit ID 0 is a global command. When setting unit ID only that unit is allowed to be connected and Global ID is used. This is the case for Enable Unit ID change and Set Unit ID commands. All other commands may be used globally with all units connected. In Global mode responses are not generated when in RS-485 mode..

Commands

i Intensity followed by a value of 0-255 for intensity, 0 = none, 255 = 100%

d Disable, 0 = Off, 1 = On

r Reset, 0 = all parameters to default, 1 = Reset Status Register

e Enable Unit ID change, 1 = enable, 0 = disable

u Set Unit ID, 0-255

w Write Parameters, Status and Control into EEPROM, 0 = write default values, 1 = write current values

v Return the software revision level.

- s Report Status, 0 required as a default parameter. The response message is the normal response plus an eight-digit bit status byte reported in binary to indicate conditions set in the unit. The representation is shown below.

Reported in positive logic form:

- D7 unused set to 0
- D6 unused set to 0
- D5 unused set to 0
- D4 1 = Unit ID Change enable bit set, 0 = not enabled, normal
- D3 unused set to 0
- D2 1=feedback out of range, 0=normal
- D1 1 = overcurrent detected, 0 = normal
- D0 1 = over temperature detected, 0 = normal

The Microprocessor communications port will reset (go back to searching for a “\” to start a new command reception) after a 5 second period of no communication activity.

-PE Ethernet Option

This option is provided with the microprocessor option. The module along with the application software allows for an Ethernet based communications link. See Appendix A for configuration information for the port.

To ensure EMC compliance use only shielded type Ethernet interface cable.

-CE Option

The unit is supplied with an international line cord

Accessories

FTIII18022	Accessory, Light source Adapter, ACMI
FTIII16867-02	Accessory, Light source Adapter, .625 Standard- FTI, Chiu, IT, Techniquip
FTIII16867-17	Accessory, Light source Adapter, .472 Schott KL2500 series. (for P/N 157320)
FTIII16867-03	Accessory, Light source Adapter, .393 Schott KL1200 series.
FTIII16867-16	Accessory, Light source Adapter, .320 Schott KL series.
FTIII16867-04	Accessory, Light source Adapter, .240 Schott KL series
FTIII16867-13	Accessory, Light source Adapter, .315, StockerYale, DJ, Techniquip(SY)
FTIII16867-14	Accessory, Light source, Adapter, .625, StockerYale, DJ , Techniquip(SY)
FTIII16867-15	Accessory, Light source Adapter, .718, Schott-Fostec
FTIII16867-05	Accessory, Light source Adapter, .590 – Moritex, Volpi, DJ

FTIII16867-06	Accessory, Light source Adapter, .190 Dolan Jenner B type
FTIII16867-06-IND	Accessory, Light source Adapter, .250 FTI Industrial cables
FTIII18233	Accessory, Input adapter to connect FTI Standard endtips into .718 Schott light source Bezels
FTIII18233IND	Accessory, Schott Light source Adapter, .089 FTI Industrial cables
FTIII21249-01	Accessory, MO150, LO50 and LO35 Light source adapter, Storz
FTIII21249-02	Accessory, MO150, LO50 and LO35 Light source adapter, ACMI
FTIII21249-03	Accessory, MO150, LO50 and LO35 Light source adapter, Wolf
FTIII21249-04	Accessory, MO150, LO50 and LO35 Light source adapter, Olympus
FTIII21249-05	Accessory, MO150, LO50 and LO35 Light source Adapter, Pilling
FTIII21249-06	Accessory, MO150, LO50 and LO35 adapter for Schott Lightguides
FTIII16867-07	Accessory, Light source Filter, Dichroic, Green
FTIII16867-08	Accessory, Light source Filter, Dichroic, Red
FTIII16867-09	Accessory, Light source Filter, Dichroic, Yellow
FTIII16867-10	Accessory, Light source Filter, Dichroic, Blue
FTIII16867-11	Accessory, Light source Filter, Dichroic, Daylight
FTIII16867-12	Accessory, Light source Filter, Dichroic, Heat mirror
FTIII10029	Accessory, Light source Lamp 150W, 21.0V EKE
FTIII10846	Accessory, Light source Lamp 150W, 21.0V EJA
FTIII16933	Accessory, Light source Lamp 150W, 20 V DDL
FTIII16934	Accessory, Light source Lamp 150W, 21V EKE 44° Gold coated reflector for IR applications
FTIII25509	Accessory, Light source Lamp 150W, 21V EKE 44° Aluminum coated reflector for IR applications

Customer Support

FTI maintains support services to assist you. Please contact your representative for support. You may also contact us directly by phone, facsimile, mail or e-mail at:

Fiber optics Technology, Inc
1 Quasset Road
Pomfret, CT 06258 USA
800.433.5248 toll-free within US and Canada
+001 860.928.0443 International
Monday - Friday 8AM - 5PM EST USA
+001 860.928.7665 Facsimile
E-mail: info@fiberoptix.com

Be sure to have your part number and serial number available, as well as a complete description of the problem or situation for the quickest, most accurate assistance.

Service/RMA Policy

There are no user serviceable parts in this product. Service required for any reason must be performed by FTI or an authorized service representative. All service outside warranty will be performed with purchaser's approval and charged according to normal service charges in effect at the time.

To return any item, whether for warranty repair or chargeable servicing, an RMA number (Return Material Authorization) must be obtained from FTI. This number must be clearly visible on the shipping label. All shipping must be prepaid.

If the light source was used in a biohazard environment, you may also be asked to supply a certification stipulating the conditions of service, including a list of materials the light source may have been exposed to. This unit must be clean and decontaminated before shipment. FTI reserves the right to return any product contaminated with blood or other organic material without repair.

All units will ship prepaid using our shipping method of choice. Alternate shipping methods will be shipped freight collect.

Warranty

FTI warrants its family of light sources to be free from defects in material and workmanship for a period of two years from date of shipment unless stated otherwise in a specific separate published warranty.

If any FTI product is found to have defects in material or workmanship, the purchaser should notify FTI promptly and request an RMA number. After an RMA number is assigned, purchaser may return defective products prepaid to the originating FTI facility.

FTI, at its sole discretion, will repair or replace FTI products found to be defective, and return said products, prepaid. FTI's correction of any defects, by the grant of credit, repair, or replacement, shall constitute fulfillment of all obligations and liability to the purchaser hereunder.

FTI is not responsible for damage to product caused by abuse or neglect, unauthorized installation, maintenance, use, repair, or adjustment. Any of the aforementioned actions shall make this warranty null and void and shall relieve FTI from any further responsibility hereunder.

FTI shall not be liable for an incidental, special, or consequential damage in any claim action, suit or proceeding arising under this warranty or any other part of the agreement of sale between FTI and the purchaser, nor shall there be any liability hereunder for labor claims, loss of profits or good will, repairs or other expenses incidental to replacement.

The foregoing warranty is in lieu of all other representations and warranties expressed or implied, written or oral, including warranties of merchantability or fitness of the goods for a particular purpose, unless exception is offered in writing by an officer of FTI, or separate published warranty is cited for specific product groups.

The warranty is void if:

- We determine the product has been subjected to neglect or misuse or has been installed following procedures not in accordance with our instruction manual.
- Unauthorized repairs or modifications have occurred.

- The warranty seal has been broken or the serial number label has been altered

Our obligation is limited to repair or replacement, FOB Pomfret CT. We will not be held responsible for consequential damages, transportation, installation, adjustment or other expenses arising in connection with our products or parts.

This warranty is in lieu of all other statements or guaranties, written or implied by FTI or our authorized representatives.

Liability

Any warranty implied under State Law shall be limited to two years from original delivery to original purchaser. Specifically excluded from FTI liability is damage resulting from acts of any deity, malicious mischief, vandalism, riots, wars, improper installation or neglect in the operation or maintenance of the unit or misunderstanding of the properties of the unit. Under no circumstances shall FTI be obligated for consequential or other damages of any kind or description, losses or expenses in connection with or by reason of the use of, or inability to use this unit for any reason. The stated warranty provides the purchaser with specific legal rights, and there may be additional rights which vary from State to State. Some states, for example, do not allow exclusion of consequential damage.